



# NEO LUMBER

INSTALLATION GUIDE



## Introduction

---

The following LUX Architectural Products Neo Lumber Installation Guide has been prepared and intended for persons with experience in the field of siding and soffit installation and who have a fundamental knowledge of basic building practices. Warranty may be void if proper application and installation practices are not followed.

LUX is designed to be efficient and simple to install. Still, precision and attention to detail are required for a successful install, and it is highly recommended that an experienced professional install the product.

The information provided in this document is offered in good faith and believed to be reliable but is made without warranty, express or implied, as to merchantability or fitness for a particular purpose. Readers should review this document in conjunction with their design professional's advice, construction drawings, manufacturer's technical literature, building code, and fire code. LUX Architectural Products does not assume any responsibility for the reader's compliance with applicable laws and regulations.

## Getting Started

---

When beginning the installation of your LUX Architectural Products order, always check for any potential issues with your product such as damage that might have occurred during shipping, post-manufacturing defects, or deformity from improper unpacking.

Also, check to make sure that your colour and product match your order. This is imperative because once installation has begun, any outstanding issues become the responsibility of the installer. If you find an issue, contact LUX immediately before starting the installation.

It is crucial that you ensure you have enough product to complete your installation. Although LUX Neo Lumber's finish is generally very consistent, all pre-painted metals are batch-sensitive. This means it is paramount you have enough product to complete your installation from one order as the product is not guaranteed against paint batch inconsistency.

LUX Neo Lumber is designed to be tailored to the requirements of your project. This means the LUX installation begins before the material is ordered in the way of pre-planning your install. A planned install yields the most efficient installation and pleasing aesthetic, making sure all material ordered is utilized correctly.

After ensuring you have received your order free of issue, it is time to begin installing LUX. Below lists the methods for installing each particular LUX trim for different starting and termination points.

## LUX Architectural Products Features & Properties

---

All LUX Architectural Products are made from 24 gauge ASTM A792 55% Al-Zn Alloy Coated Steel prepainted in a KYNAR 500® (PVDF) high endurance paint. LUX has A ratings in fire tests, can withstand extreme weather changes and winds, is impervious to insects, requires virtually no maintenance and is warranted for a 40-year paint finish. Unlike wood, it will never rot or support mould or mildew and is easy to clean and maintain. LUX is also proud to hold an official Canadian Construction Materials Centre (CCMC) certification number 14137-L.

# NEO LUMBER INSTALLATION GUIDE



## PROFILES

NEO LUMBER 2 PCS 2.375" X 2.375"

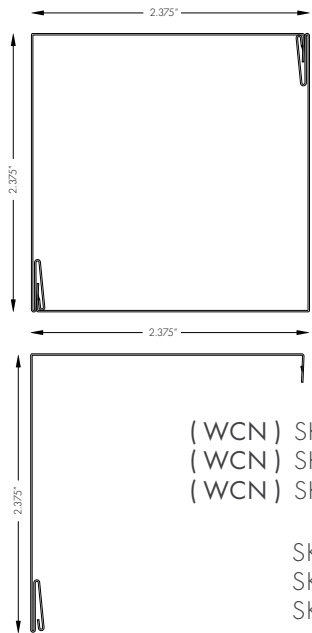

- ( WCN ) SKU **716201** 8'
- ( WCN ) SKU **716202** 10'
- ( WCN ) SKU **716204** 12'
  
- SKU **706201** 8'
- SKU **706202** 10'
- SKU **706204** 12'



INSERT

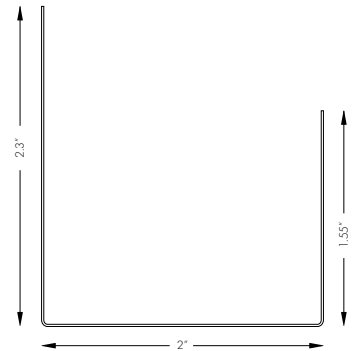

SKU **716200**

NEO LUMBER 2 PCS 3.375" X 3.375"

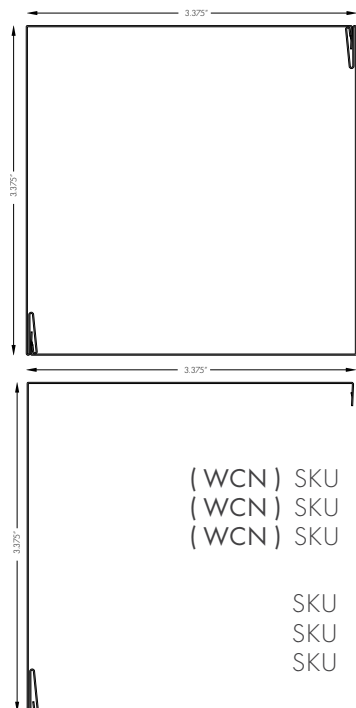

- ( WCN ) SKU **716217** 8'
- ( WCN ) SKU **716218** 10'
- ( WCN ) SKU **716220** 12'
  
- SKU **706217** 8'
- SKU **706218** 10'
- SKU **706220** 12'



INSERT

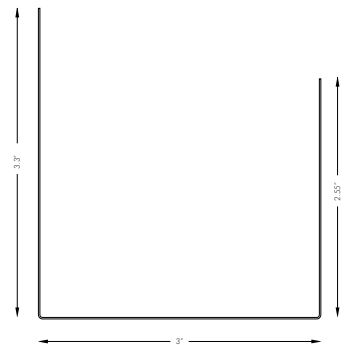

SKU **716199**

# NEO LUMBER INSTALLATION GUIDE



## PROFILES

**SPECIFY TYPE A OR B  
WHEN ORDERING**

NEO LUMBER 2 PCS 1" X 3.75" ( NOMINAL ) **TYPE A**

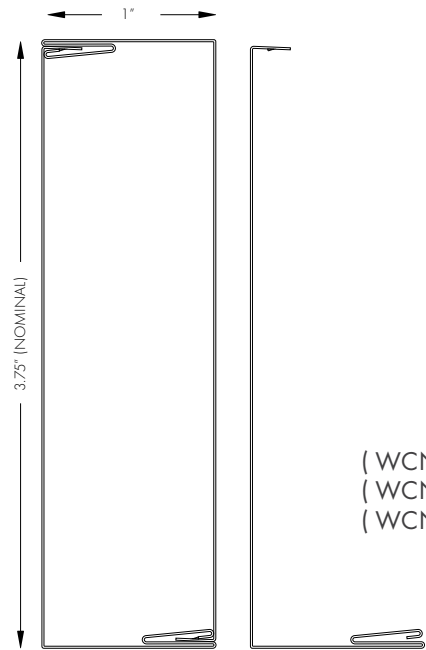

- ( WCN ) SKU **716205** 8'
- ( WCN ) SKU **716206** 10'
- ( WCN ) SKU **716208** 12'
  
- SKU **706205** 8'
- SKU **706206** 10'
- SKU **706208** 12'



INSERT

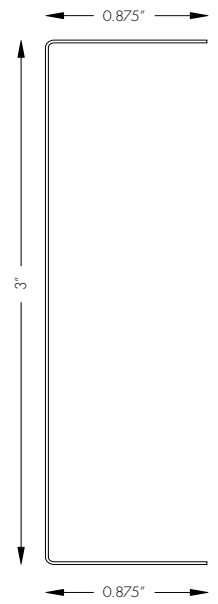

SKU **716198**

NEO LUMBER 2 PCS 1" X 3.75" ( NOMINAL ) **TYPE B**

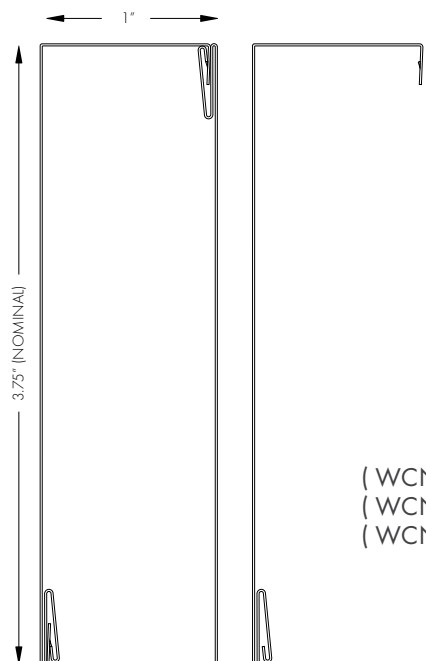

- ( WCN ) SKU **716205** 8'
- ( WCN ) SKU **716206** 10'
- ( WCN ) SKU **716208** 12'
  
- SKU **706205** 8'
- SKU **706206** 10'
- SKU **706208** 12'



INSERT

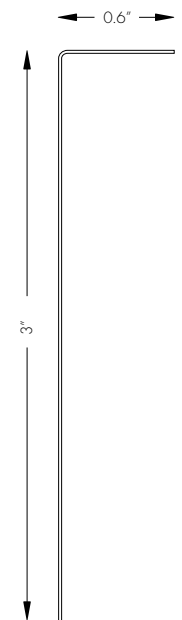

SKU **716197**

## PROFILES

**SPECIFY TYPE A OR B  
WHEN ORDERING**

NEO LUMBER 2 PCS 1" X 5.75" ( NOMINAL ) **TYPE A**

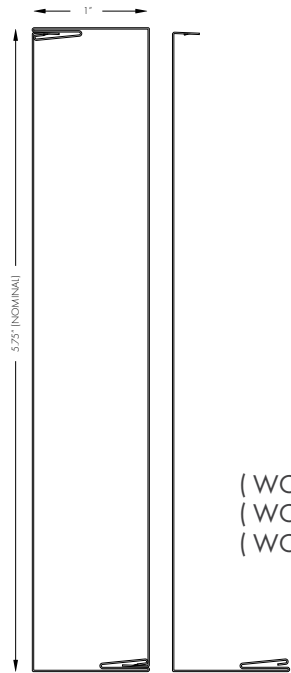

- ( WCN ) SKU **716209** 8'
- ( WCN ) SKU **716210** 10'
- ( WCN ) SKU **716212** 12'
  
- SKU **706209** 8'
- SKU **706210** 10'
- SKU **706212** 12'



INSERT

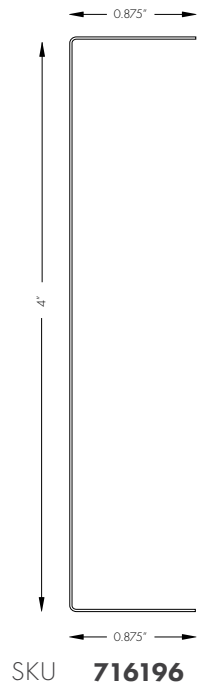

NEO LUMBER 2 PCS 1" X 5.75" ( NOMINAL ) **TYPE B**

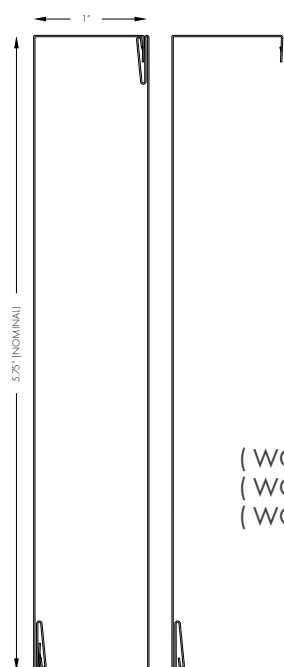

- ( WCN ) SKU **716209** 8'
- ( WCN ) SKU **716210** 10'
- ( WCN ) SKU **716212** 12'
  
- SKU **706209** 8'
- SKU **706210** 10'
- SKU **706212** 12'



INSERT

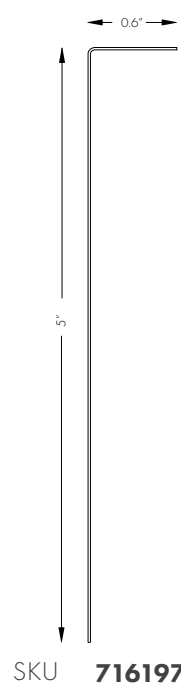

# NEO LUMBER INSTALLATION GUIDE



## PROFILES

**SPECIFY TYPE A OR B  
WHEN ORDERING**

NEO LUMBER 2 PCS 2" X 4.75" ( NOMINAL ) **TYPE A**

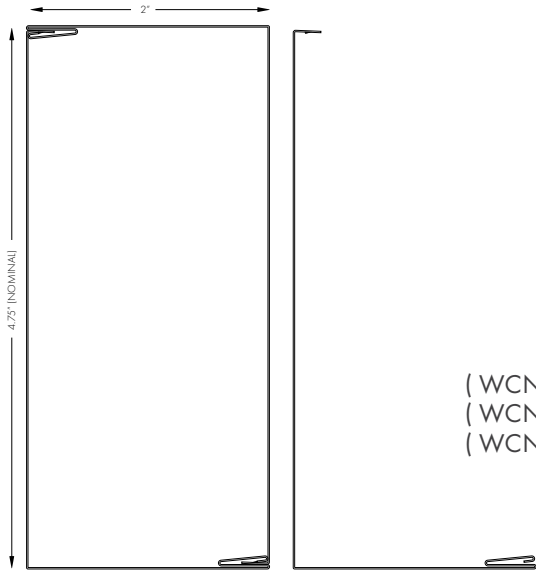

- ( WCN ) SKU **716213** 8'
- ( WCN ) SKU **716214** 10'
- ( WCN ) SKU **716216** 12'
  
- SKU **706213** 8'
- SKU **706214** 10'
- SKU **706216** 12'



INSERT

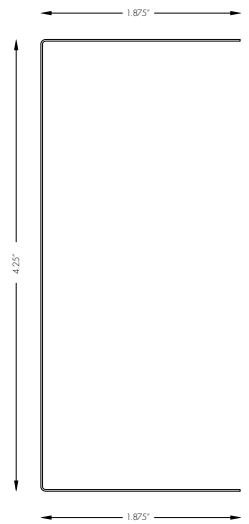

SKU **716194**

NEO LUMBER 2 PCS 2" X 4.75" ( NOMINAL ) **TYPE B**

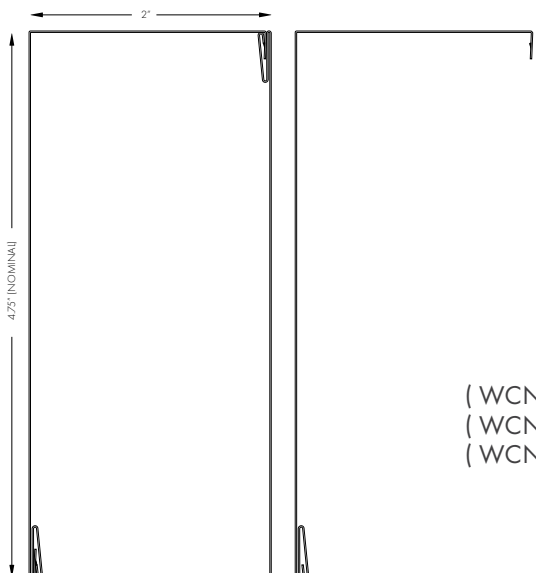

- ( WCN ) SKU **716213** 8'
- ( WCN ) SKU **716214** 10'
- ( WCN ) SKU **716216** 12'
  
- SKU **706213** 8'
- SKU **706214** 10'
- SKU **706216** 12'



INSERT

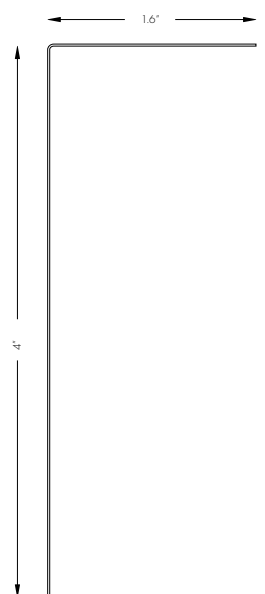

SKU **716193**

## Safety Considerations

---

Always wear and use appropriate Personal Protective Equipment (PPE), taking all precautions to protect eyes during installation and cutting. Gloves are recommended as there can be sharp corners and edges on the LUX Neo Lumber. When cutting or being exposed to airborne particles, always wear an appropriate dust mask. Refer to the OHS Code (OSHA in the U.S.A.) for further requirements and safety measures for Jobsite siding installations.

## Storage Considerations

---

Pre-painted metal siding is subject to premature corrosion if they are not handled and stored correctly at the jobsite prior to installation. Excessive storage periods or poor storage conditions often result in water intrusion into panel bundles. Prolonged exposure of bundled panels to wet conditions can cause paint blistering and substrate corrosion. Wet Stack Corrosion can occur within two weeks if the storage conditions are poor or improper storage practices are not followed.

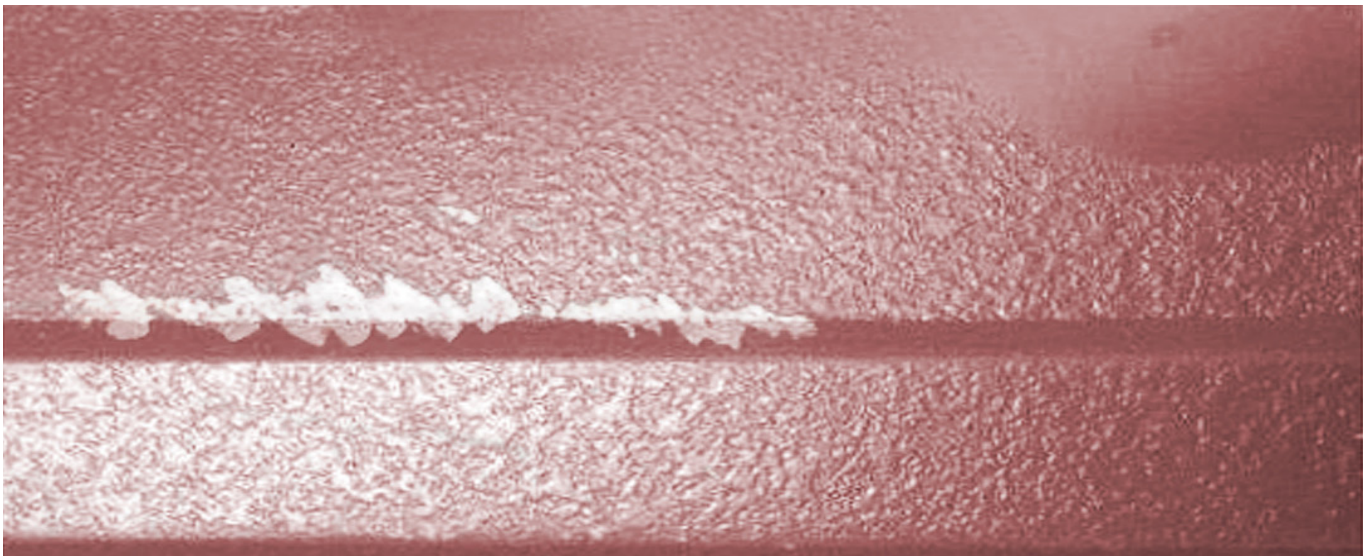

Close-up image of severe "Wet Stack Corrosion." Note smooth, normal surface in upper right corner.  
Note when scratched, the primer has been compromised as well as the presence of Zinc Oxide (white rust).

## Environmental & Service Conditions

If proper precautions are not taken during transport, water may be present between the panels upon delivery at the job site. When water or water vapour collects along the sides of a panel bundle, it may travel between the panels by capillary action. Humidity and temperature cycles can also promote water intrusion into stored panel bundles through condensation. Finally, rain and snow are other potential sources of water that can cause storage corrosion of pre-painted panels.

Besides water, two other most important factors contributing to the corrosion of stored pre-painted panels are exposure time. Corrosion will accelerate with increased temperature.

## Storage Considerations

---

Given enough time, panel bundles will eventually become wet, and storage corrosion may occur under most job site conditions. Storage corrosion can be prevented by:

- Reducing site storage time
- Decreasing water contact
- Moderating temperature extremes

Special case factors not considered here are the presence of aggressive soluble chemicals, such as sulphur and chlorine compounds, that might be present in polluted atmospheres, road salt contaminants, or marine environments. It is reasonable to assume that these soluble species would accelerate storage corrosion.

### Job Site Storage

Prolonged storage will always increase the likelihood of storage corrosion. Therefore, the best prevention is to minimize storage time. Proper storage limits the collection of water from rain, snow and condensation on the panel surfaces. Storage under a roof is highly recommended. If panel bundles have to be stored outdoors, several precautions must be taken to prevent storage corrosion. The panel bundles should be stored in a level area out of the way of other construction activities to minimize the number of bundle movements required at the job site. If the bundles are stored on the ground, a plastic ground cover must be put down under the bundle to minimize condensation of water from the ground onto the panels. The bundles must then be raised off the plastic ground cover to avoid contact with water puddles and allow for air circulation around the bundle to promote drying of condensed water.

Wet, uncured or pretreated lumber should not come in contact with the panel bundles. The panels must be stored at an angle to promote drainage of water off the bundle. Sufficient support must be provided to the raised and angled bundles to avoid excessive bowing, which may result in low spots that could hold water.

The bundle must be sheltered entirely with a loose-fitting waterproof tarp to protect the bundle during rain or snow events but allow for air circulation and drying of condensed water. A loose-fitting tarp also shades the bundle from direct sunlight and should act to moderate extreme temperature fluctuations.

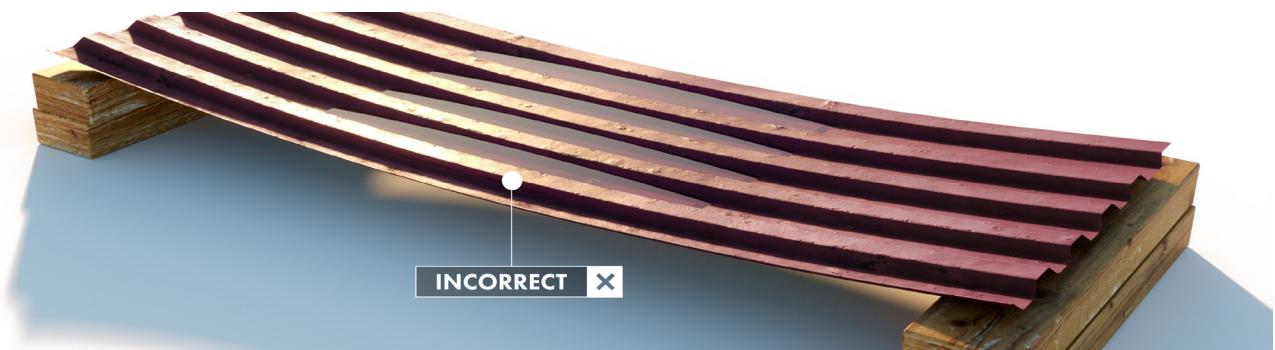

Insufficient support in the center of long panels allow "Bowling" or "Sagging" that traps water in the center of the panel length.

It is crucial NOT to snugly cover panels with a tarp when on the ground. By covering pre-painted panels in this manner, airflow is prevented, and moisture in the ground is trapped under the tarp and. The effect is worse than just letting the bundles of pre-painted panels sit uncovered in the rain. This is because a "humidity chamber" has been created, and sunlight will heat the tarp and accelerate corrosion by means of increased humidity pulled from the ground below.

## Storage Considerations

---

### Job Site Storage

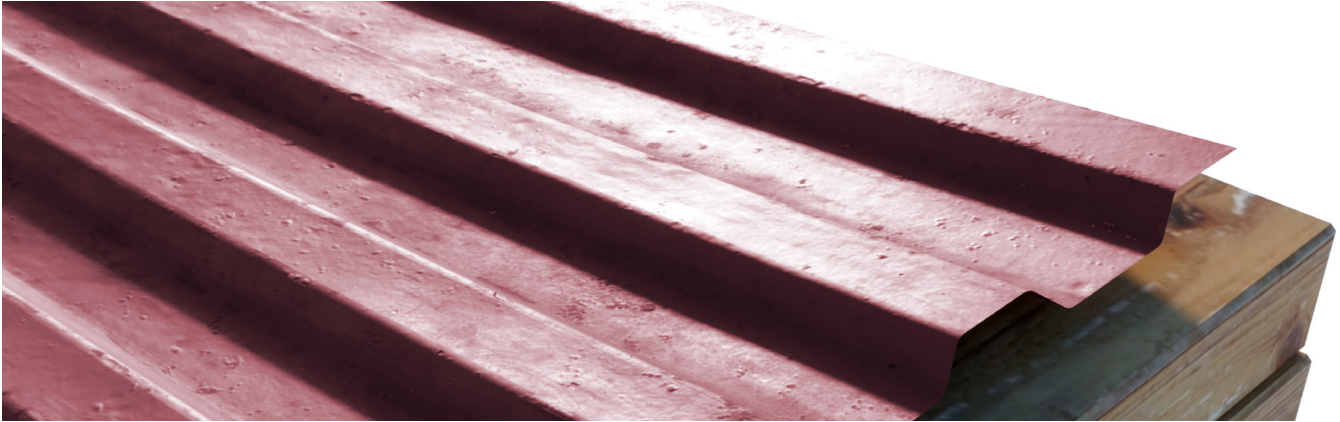

After just 3 months covered in the manner above, the panel bundle is opened to reveal that moisture has made its way into the layers of sheets.

Proper storage of bundled pre-painted panels is essential and, to some, considered “time-consuming and costly” to do. However, failure of your panels is an even more costly idea when you have to reorder and wait for delivery. Other costs associated with delays in Jobsite completion as well as material replacement are things to consider when debating the use of proper storage methods.

### NCCA Storage Methods

The National Coil Coaters Association (NCCA) has developed a time tested storage method for pre-painted, bundled panels. This section will lay out the steps for proper storage that will assure your panels remain dry and defect free when it comes time to install them on your structure.

#### STEP 01



Your pre-painted bundle should be placed on a tarp to prevent ground moisture from being a factor. The bundle should then be placed on top in a sloping position. This allows any moisture that may already be present to gravitate out.

**Storage Considerations**

---

**NCCA Storage Methods**

STEP 02

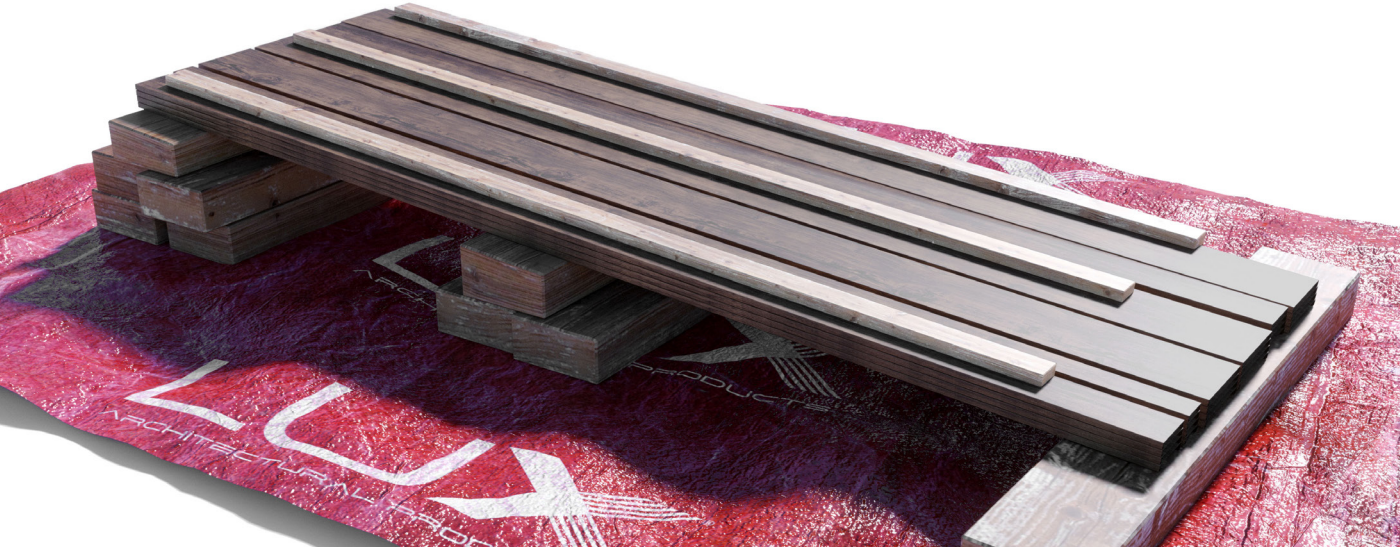

Place scraps of dimensional lumber on the bundles "Cover Sheet." This is to keep the top tarp from resting directly on the panels to increase airflow, which will allow moisture to escape.

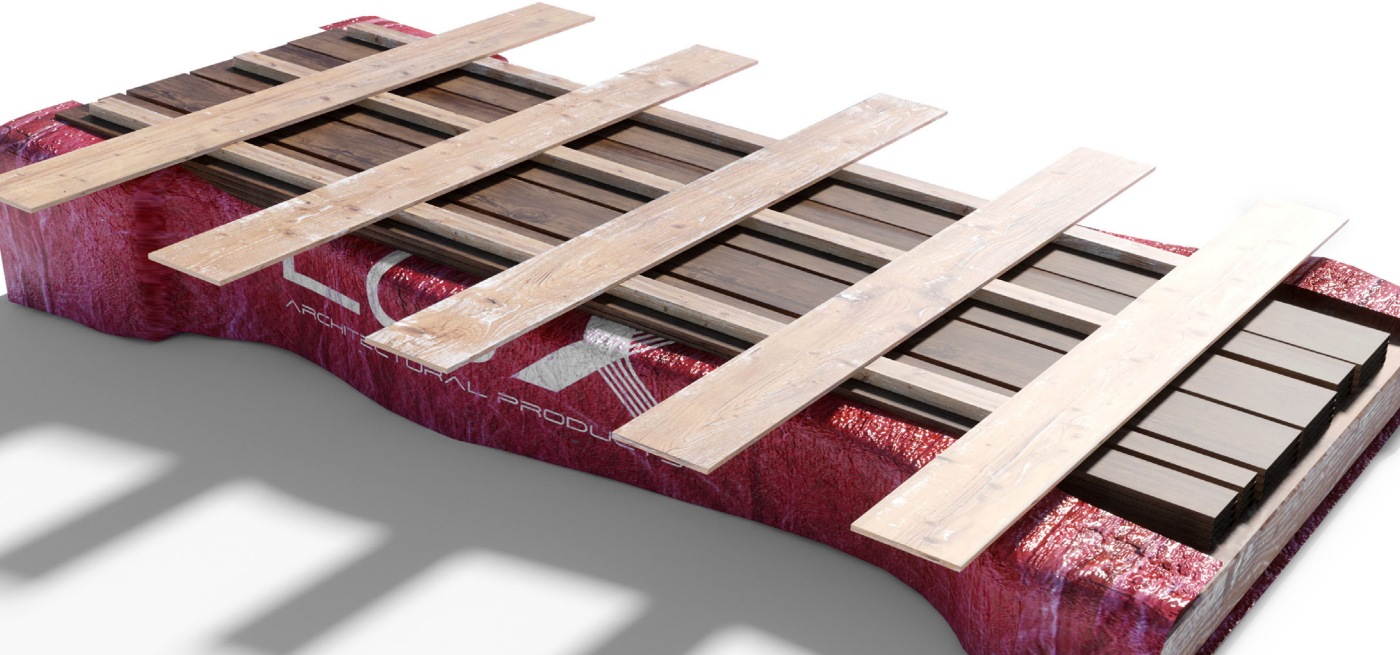

If you roll the edges of the bottom tarp up as seen above, cutting a hole in the lowest area of the bottom tarp will allow water to escape.

## Storage Considerations

---

### NCCA Storage Methods

#### STEP 03



Roll your top tarp over the stack allowing enough tarp to stretch out at least 12 inches from any edge of the panel stack.

#### STEP 04



When completed, this method will increase the storage life of your panels. Unused portions of open bundles must be recovered. The condition of the tarps and paper wrapping of stored bundles should be inspected daily for damage, puddles and snow accumulation. Damage to packaging or tarps must be repaired, and snow accumulation or puddles should be removed. If water is present in the panel bundles, the Panels must be separated and wiped dry with a clean, soft cloth and stacked with a space between each panel so that air circulation can complete the drying process.

There is currently no test method to determine the storage corrosion resistance of pre-painted sheet products that has been correlated with actual storage performance; however, there are a number of test methods that have been utilized by the building products industry.

## Unwrapped Products

---

Unwrapped or inadequately stored metal siding bundles can often result in water intrusion into panel bundles, causing potential damage such as component degradation, mold, paint degradation, rust, or the weakening of building materials. Pre-painted building panels are also subject to premature substrate corrosion and paint blistering if proper wrapping and storage considerations are not followed. It is the responsibility of the user to ensure proper storage and wrapping to prevent these issues. Failure to properly follow the wrapping, handling, and storage procedures outlined in this guide, or failure to protect your materials from moisture, will void any warranties. We assume no liability for damages resulting from inadequate wrapping, storage or protection methods.

## Warranty

---

Your warranty may be void if proper application practices are not followed. That includes the practices outlined in this guide as well as the LUX Neo Lumber installation guide. Additionally, your warranty may be void if you do not follow local building codes.

The information provided in this document is reliable and offered in good faith but is made without warranty, expressed or implied, as to merchantability or fitness for a particular purpose. Readers should review this document in conjunction with their design professional's advice, construction drawings, manufacturer's technical literature, building code, and fire code. LUX does not assume any responsibility for the reader's compliance with applicable laws and regulations.

## Code Compliance

---

The applicable Building Codes and Fire Codes are determined based on the project site location. There can be various code changes per province, city, state, county and region. LUX Architectural Panel cannot address all the various codes in this guide. Project Designers, Builders, Architects, and Engineers must understand the applicable codes and install exterior cladding products within the guidelines of these codes. The requirements of the Local Building Codes must be observed as a minimum requirement of the installation of LUX Neo Lumber. LUX Products adhere to the CGSB-93.4-92 as per standards Council of Canada, National Research Council Canada, National Building Code of Canada. In the United States, compliance with ASTM E330 or equivalent standards, as well as the International Building Code (IBC), may be required."

## Care & Maintenance

---

While factory-applied finishes for metal building panels will last many years longer than ordinary paints, it is recommended to clean them thoroughly on a routine basis, especially when the finish is not washed by rain. Cleaning will generally restore the appearance of these products and render repainting unnecessary. An occasional light cleaning will also help maintain an aesthetically pleasing appearance.

Examples of applications requiring maintenance cleaning and inspection include roof cladding, soffits, wall cladding under eaves, garage doors, and the underside of eave gutters. Washing should be completed at least every six months. Cleaning may be required more frequently if your building is located in coastal areas, areas where marine salt spray is prevalent, or in areas where high levels of industrial fallout occur. Mild solutions of detergents or household ammonia will be sufficient for the removal of most dirt. The following cleaning solutions are recommended:

- One cup of detergent (ex. Tide®), containing less than 0.5% phosphate, dissolved into five gallons of warm water. (NOTE: The use of detergents containing greater than 0.5% phosphate is NOT recommended for use in general cleaning of building panels. NEVER BLEND CLEANSERS AND BLEACH.)
- One cup of household ammonia dissolved into five gallons of water (at room temperature) for the removal of most dirt.

The following cleaning solutions are recommended:

- One cup of detergent (ex. Tide®), containing less than 0.5% phosphate, dissolved into five gallons of warm water. (NOTE: The use of detergents containing greater than 0.5% phosphate is NOT recommended for use in general cleaning of building panels. **NEVER BLEND CLEANERS AND BLEACH.**)
- One cup of household ammonia dissolved into five gallons of water (at room temperature).

## Care & Maintenance

---

To clean the surfaces, use either solution and work from the top to the bottom of panels with a well-soaked cloth, sponge, brush (with very soft bristles), or low-pressure spray washer. The application of the cleaning solution should be gentle to prevent shiny spots. Refrain from using scouring powders or industrial solvents, since these agents may damage the paint film. Cleaners that contain solvents, such as Fantastik®, are very effective and can be used without concern. If mildew or other fungal growth is a problem and cannot be removed as outlined above, household bleach mixed at a concentration of one gallon of bleach to five gallons of water together with one cup of mild soap (ex. Ivory®) is recommended. The surface should be thoroughly rinsed with clean water after cleaning to remove traces of detergent.

All exposed metal areas, such as scratches in the finish, are susceptible to rust and should be spot-painted with touch-up paint. Also, accumulated debris such as metal particles, leaves, branches, trash, dirt, pollution fallout, etc., should be removed. Removing debris and the regular cleaning of surfaces by hosing will help prevent the settling of localized areas where accelerated corrosion can occur. Accumulations of salt deposits in coastal locations can have a particularly aggressive effect on metal products. These deposits are easily removed by a gentle hosing with clean water.

## Temperature Considerations

---

While the expansion and contraction coefficient of LUX Metal is extremely low, It needs to be considered and subject to application of Neo Lumber.

## Transportation and Handling

---

In order to maintain the integrity of LUX Neo Lumber, precautions must be taken when loading and unloading the product.

When transporting LUX Neo Lumber, ensure that it is not stacked too high or it could result in damage to the product below. Be aware of tiedown tension as overtightening can damage the product, and never stack other materials on top of the panels. When the products arrive, immediately check for any damage caused during shipping. Do not install damaged products.

## Best Practices for Working with Neo Lumber

---

**⚠ Never use a grinder to cut LUX Products. The warranty will be void as it may damage the integrity of the finish and the Galvalume Metal.**

- Screws or stainless steel rivets should never be spaced farther than 5' on centre, unsupported or 10' oncenter supported.
- Never screw in Neo Lumber panels too tight, as it will cause distortion and warping of the panel, potentially resulting in Oil Canning.
- Install panels with care; take precautions not to scratch the panel while installing on the wall or resting on the ground.
- Always use a rubber mallet or other non-marring object to tap Neo Lumber Inserts into place.
- Installers must ALWAYS follow local building code as it applies to the installation of cladding, including all rainscreen requirements.
- LUX products are supplied with a protective film or wrapped with paper, which must be removed immediately following installation.

## Cutting LUX Neo Lumber

---

There are many ways that LUX Neo Lumber can be cut and modified. Create clean cuts of the panels and trims by using a quality ferrous blade, a skill saw, a mitre saw, or a radial arm saw. Use nibblers or snips to clean up cuts or to cut lengthwise down the center



of a panel. Always wear proper protective equipment when cutting LUX and ensure that the panel and saw are on a level plane.

LUX Neo Lumber can be cut using metalworking snips, metalworking nibblers, or various power saws. A metal cutting blade such as Freud Diablo Steel Demon 48 tooth TCG Ferrous Metal Cutting Blade is recommended.

**\*Using a grinder will void the warranty as it damages the integrity of the finish and the Galvalume Metal.**

If you are using a sliding compound mitre saw, the cut will be improved if the saw is pulled across the panel toward the operator and not down onto the panel.

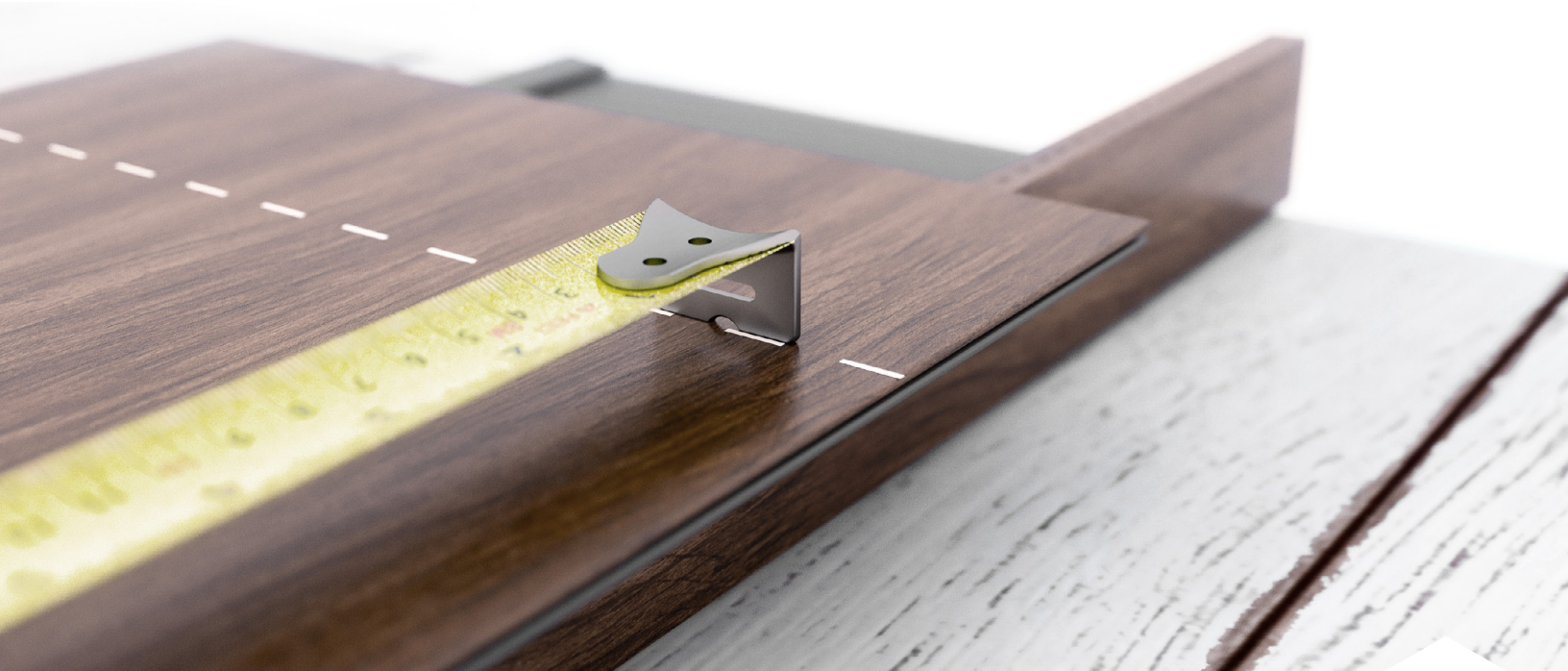

- Always accurately measure and mark your cut paths.

01



- Detail cuts such as mitres can be done with shears or snips.

02

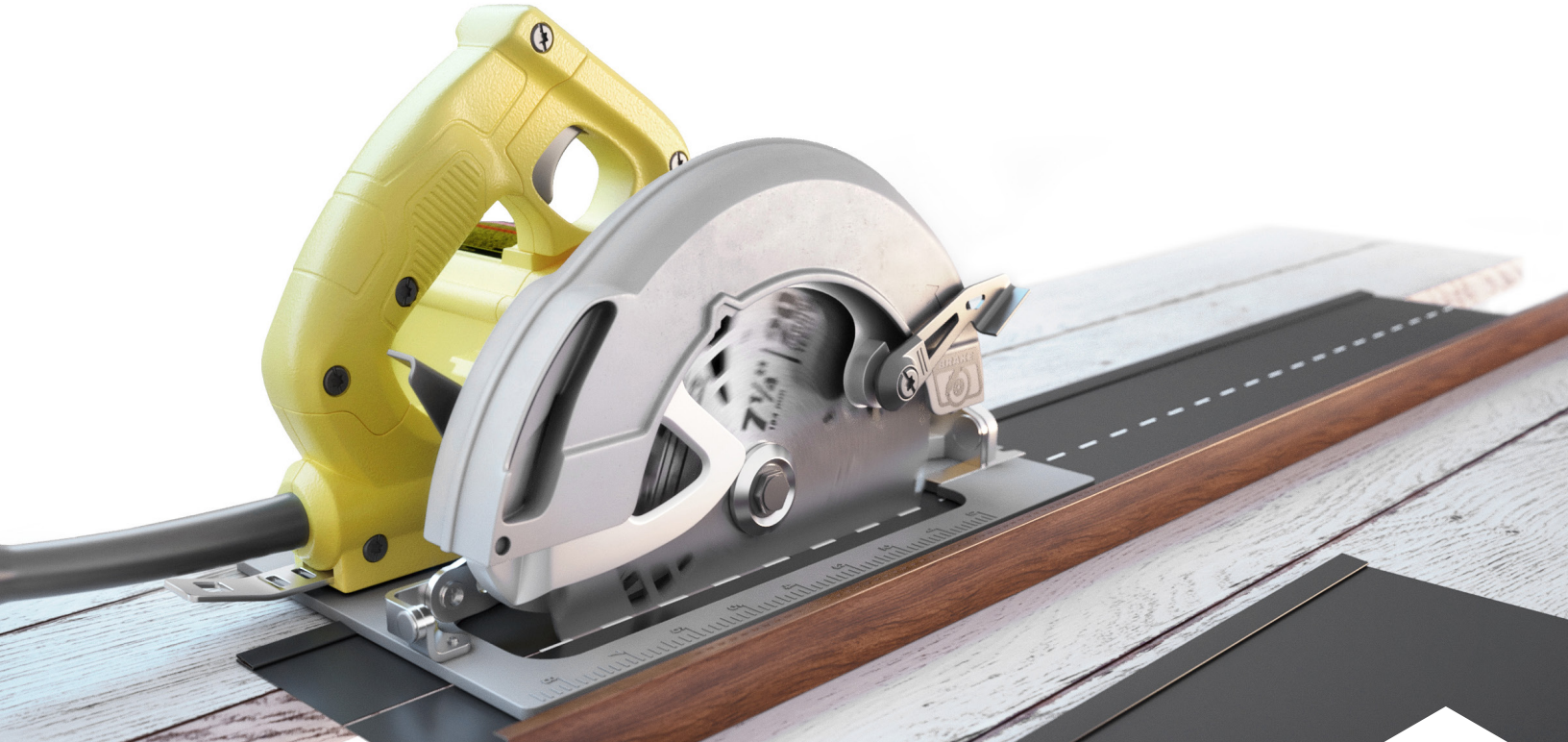

- Long cuts can be done with power saws, nibblers, or shears.

03



- Offcuts can be done with shears or snips.

04



**NEO LUMBER**  
FASTENERS



**METAL SCREW**

#14 HEX HEAD 1/25" ZINC COATED WOOD DRIVE SCREW

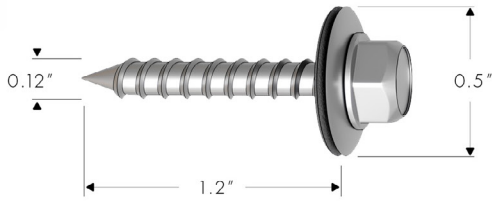

**METAL SCREW**

#12 HEX HEAD 1/25" ZINC COATED SELF TAPPING METAL SCREW

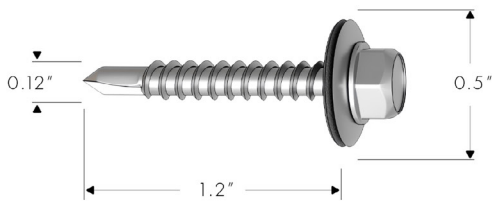

- #14 HEX HEAD 1/4" ZINC COATED WOOD DRIVE SCREW / #12 HEX HEAD 1/4" ZINC COATED SELF TAPPING METAL SCREW.

**01**

Use 0/5" self sealing washer. Always pre-drill holes in your Neo Lumber.



- By using flat washers, the bearing surface pressure is dispersed so that the risk of bearing surface sinking and the resulting looseness can be reduced (Fig. 04).

**02**



**NEO LUMBER**  
BOARD STYLE INSTALLATION





**TYPE A** BOARD STYLE



**METAL SCREW**

#14 HEX HEAD 1/25" ZINC COATED WOOD DRIVE SCREW

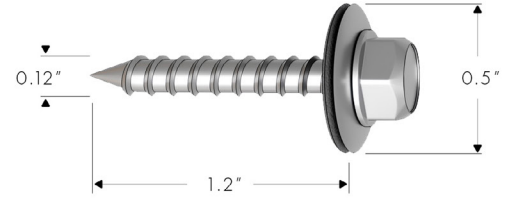

**METAL SCREW**

#12 HEX HEAD 1/25" ZINC COATED SELF TAPPING METAL SCREW

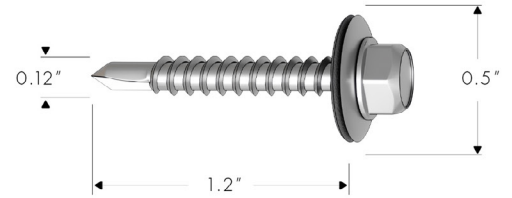

- Install first piece of Neo Lumber using screws and washer specified on page 18.

**01**

\*Type **A** yields the best result for board style installations.

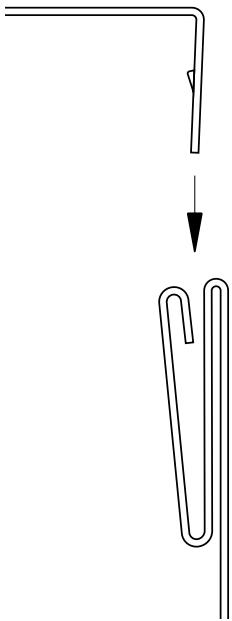

- Line up button lock with hem and insert. (Fig. 03).

**02**



- Use rubber mallet to engage lock. (Fig. 02).

**03**



## NEO LUMBER

FIN STYLE INSTALLATION



METAL SCREW

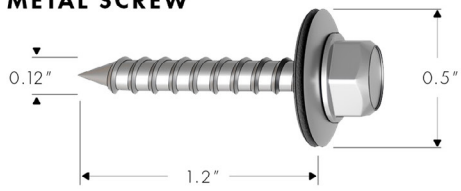

METAL SCREW

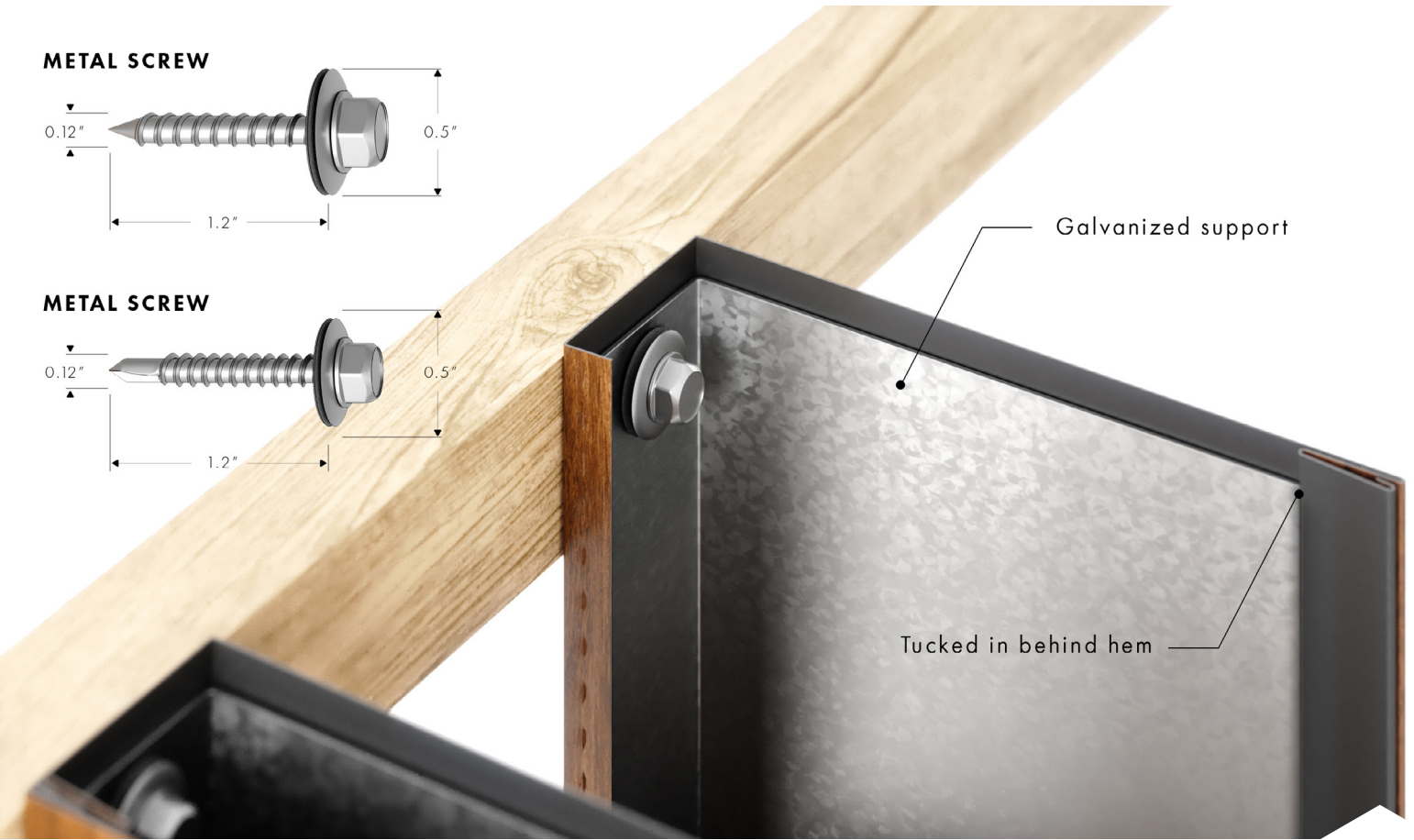
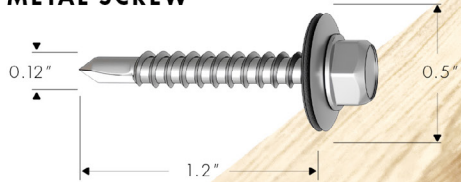

- Install first piece of Neo Lumber using screws and washer specified on page 18. We highly recommend to use galvanized support for 1" fin. ( see page 28 for more on support installation )

01

\*Type B yields the best result for fin style installations.

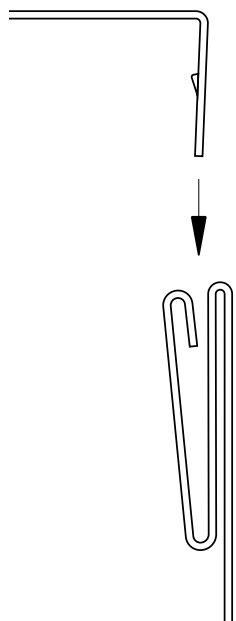

- Line up button lock with hem and insert. (Fig. 03).

02



- Use rubber mallet to engage lock.

**03**



**NEO LUMBER**  
SUPPORT INSTALLATION



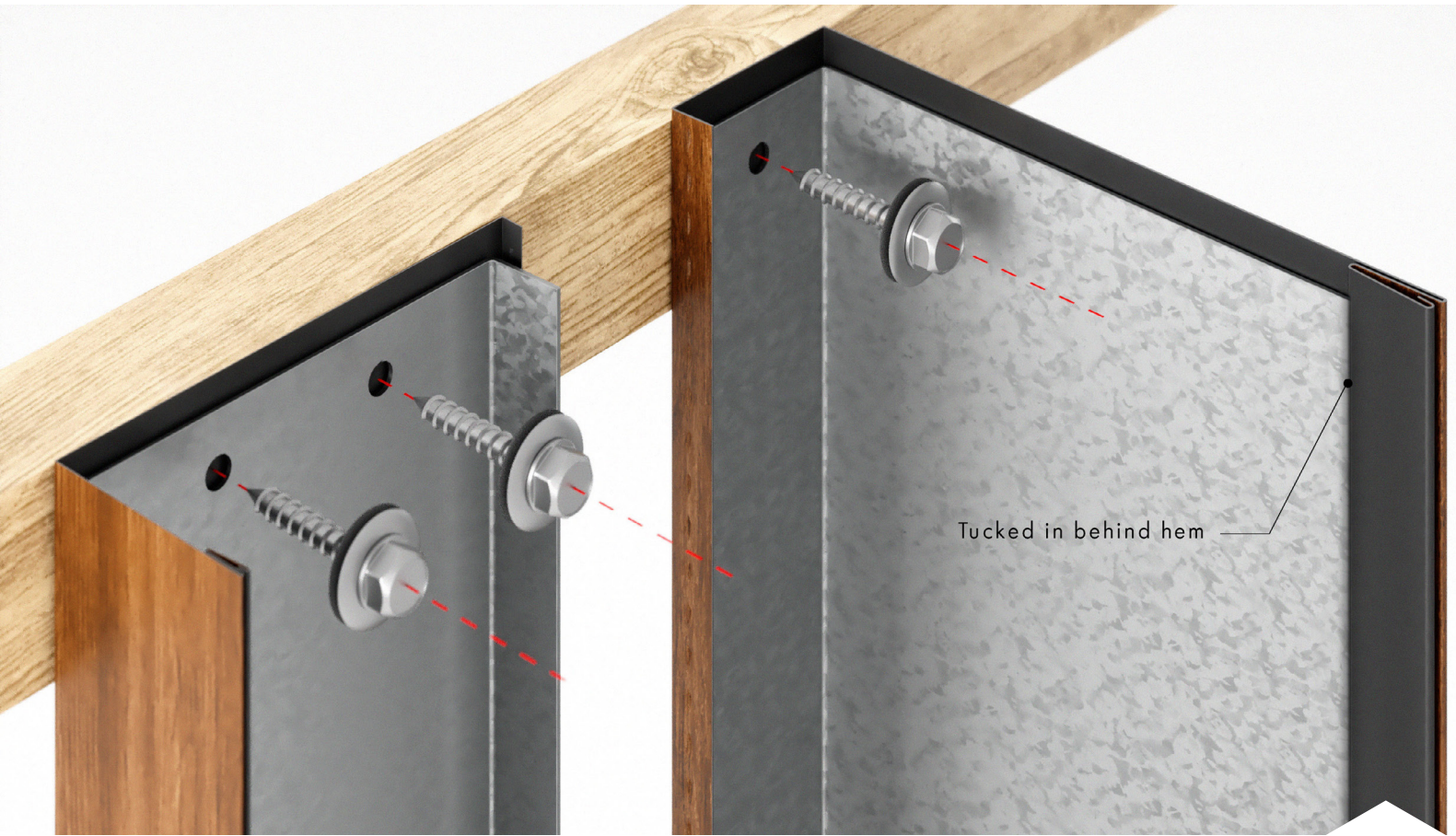

- Place your first Neo Lumber piece with galvanized support inside. Pre-drill through both Neo Lumber and galvanized support. Then screw in place

01

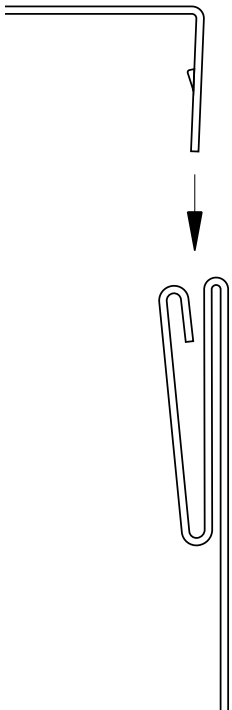

- Line up button lock with hem and insert. (Fig. 02).

02



- Use rubber mallet to engage lock.

**03**



**NEO LUMBER**  
FASTENING MATRIX



- Use the appropriate amount of screws as shown for each scenario below.



2 PCS 2.375" X 2.375"

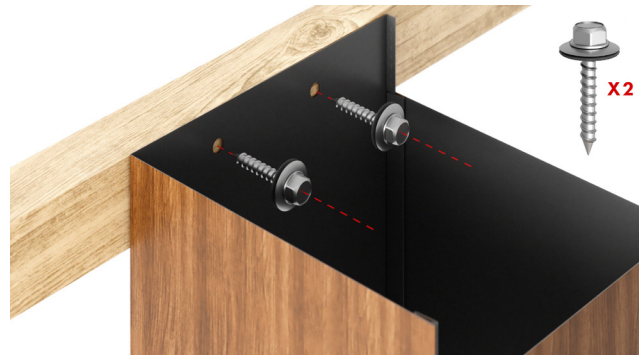

2 PCS 3.375" X 3.375"

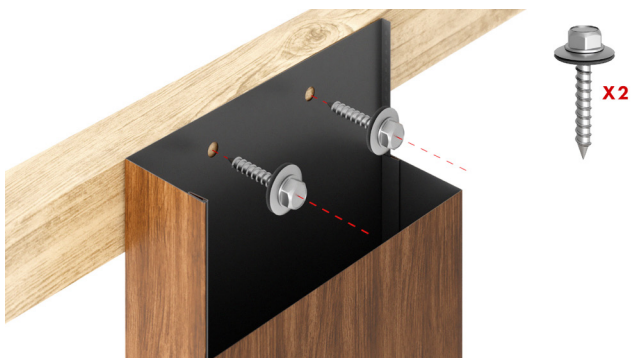

**BOARD STYLE** 2 PCS 1" X 3.75"

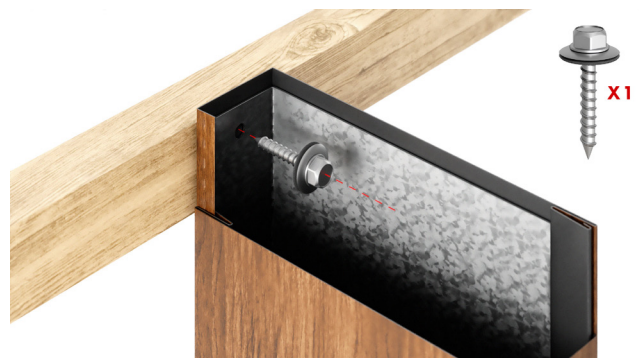

**FIN STYLE** 2 PCS 1" X 3.75"

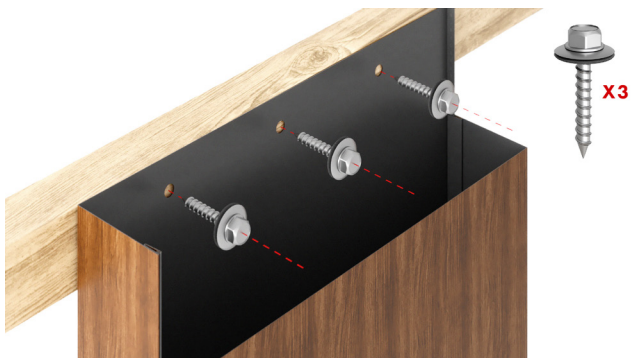

**BOARD STYLE** 2 PCS 1" X 5.75"



**FIN STYLE** 2 PCS 1" X 5.75"



**BOARD STYLE** 2 PCS 2" X 4.75"



**FIN STYLE** 2 PCS 2" X 4.75"



**NEO LUMBER**  
END CAP





- To insert your end cap, use a bead of silicone to secure. Alternatively you can secure the end cap by using a rivet as shown bellow (fig 02)

01



02

THIS COMPLETES YOUR **NEO LUMBER** INSTALLATION

