

BOARD + BATTEN
TRIMS & PROFILES

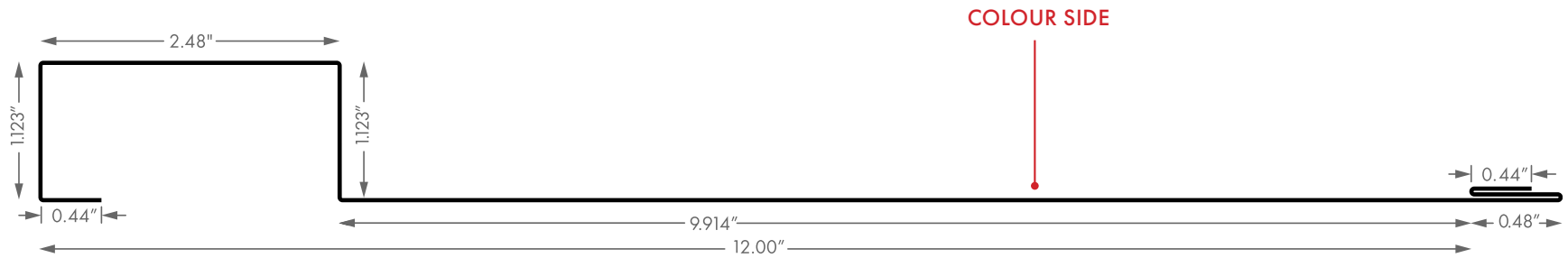

Board + Batten 12"

BOARD+BATTEN

10': #600000 | #610000 (WCNS) | 13': #600002 | #610002 (WCNS) | 20': #600004 | #610004 (WCNS)



NOTES: 16" CUT



1.25" Pocket 1 Piece J Trim

BOARD+BATTEN

10': #600020 | #610020 (WCNS)

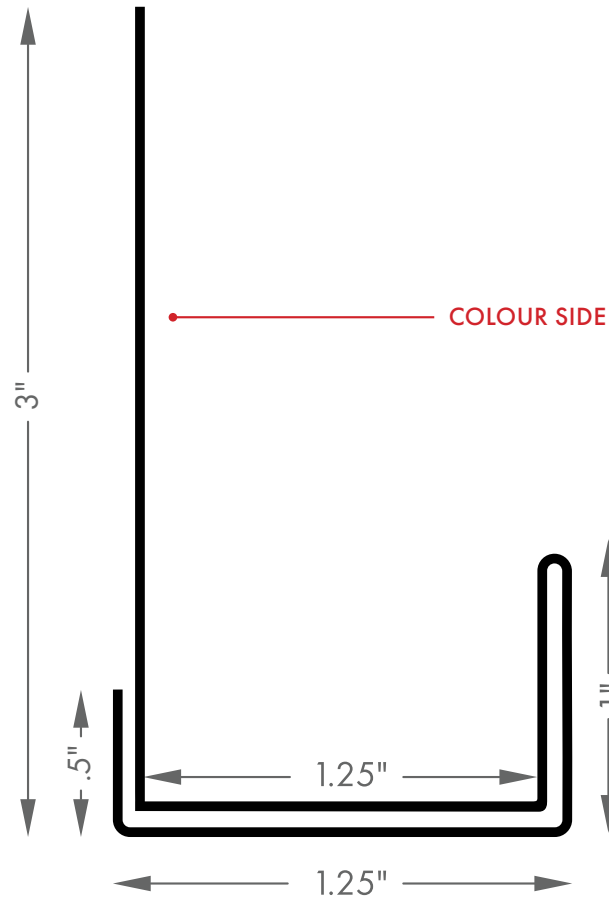

NOTES: **7" CUT**



1.25" Belt Line

BOARD+BATTEN

10': #600034 | #610034 (WCNS)

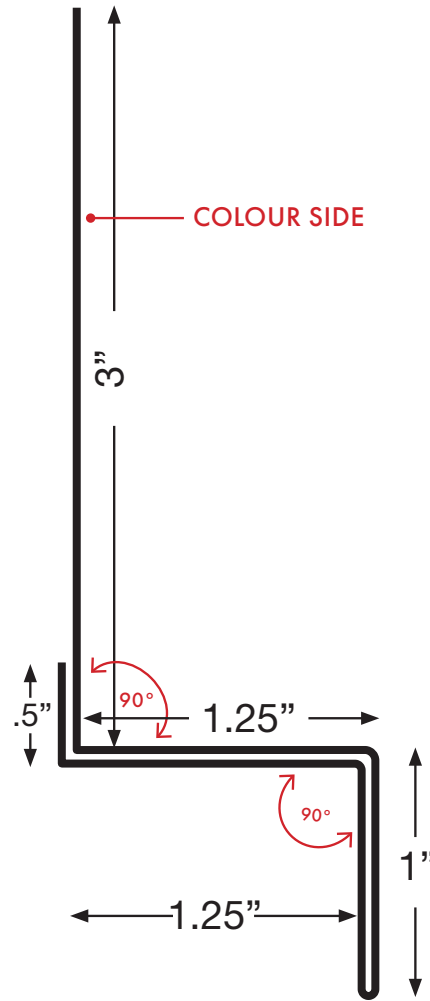

NOTES: 10' Length
8" CUT



1.25" Pocket 2 Piece J Trim

BOARD+BATTEN

10': #600022 | #610022 (WCNS)

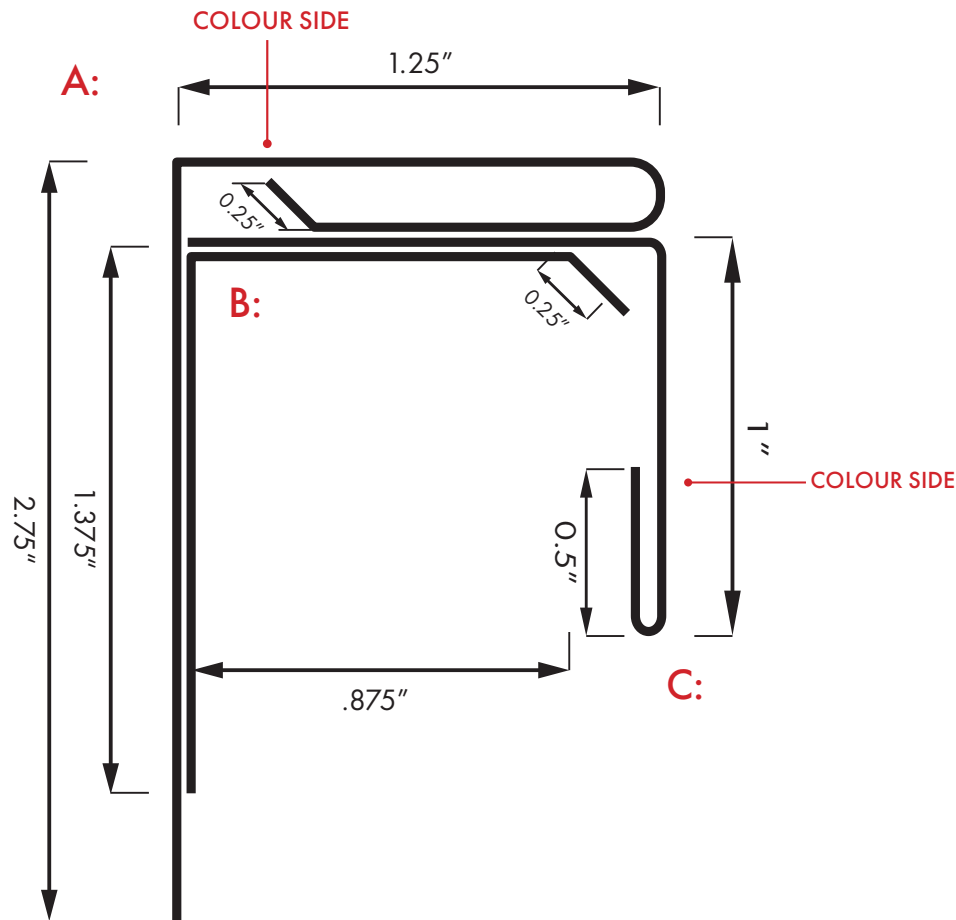

NOTES: 10' Length

BASE:

A: 5" CUT (Norlock)

B: 2.5" CUT (Norlock)

INSERT:

C: 2.75" CUT



1.25" Pocket 1 Piece OSCP

BOARD+BATTEN

10': #600026 | #610026 (WCNS)

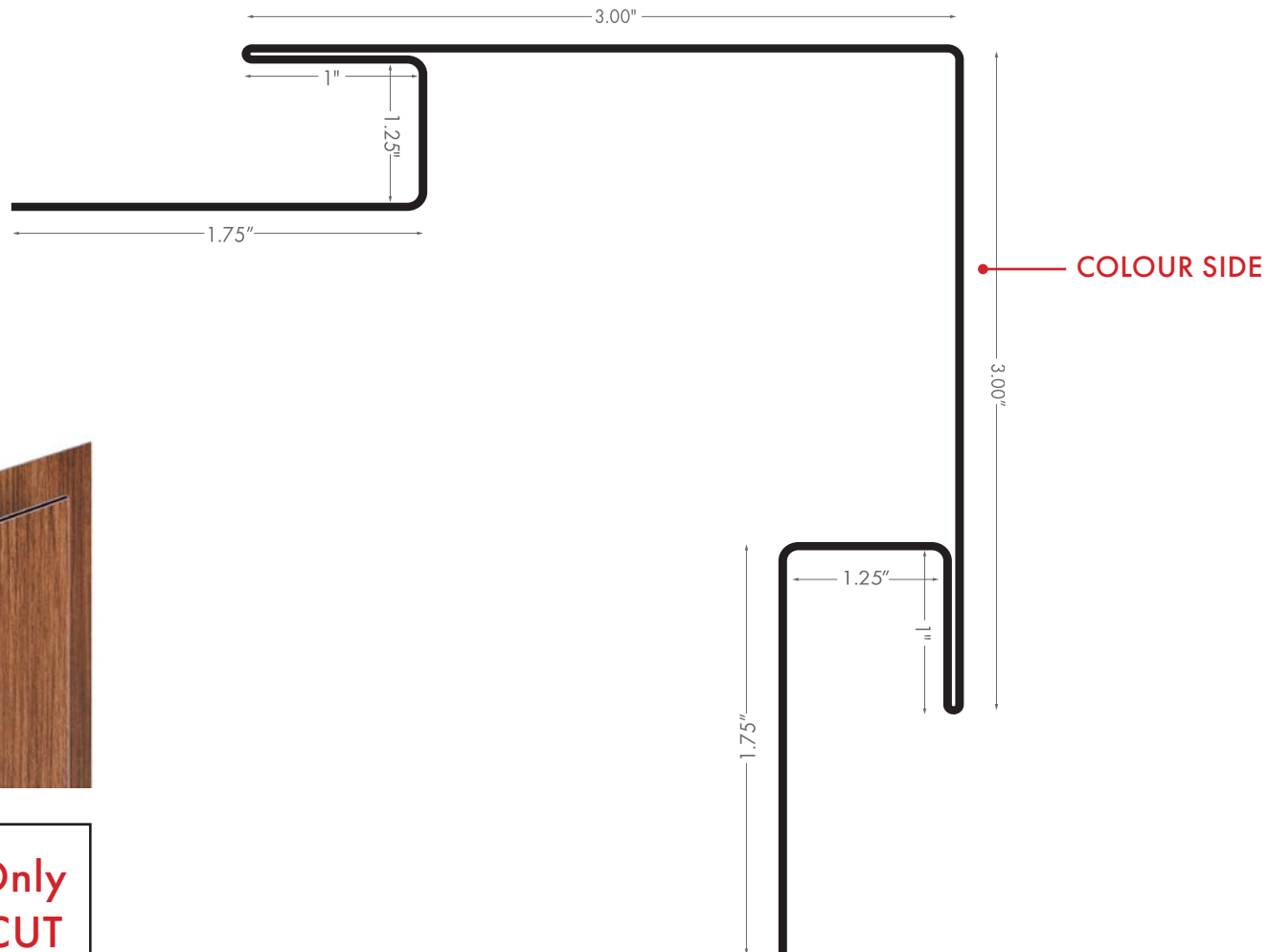

NOTES: 10' Only
14" CUT



1.25" Box Base

BOARD+BATTEN

10': #600030 | #610030 (WCNS)

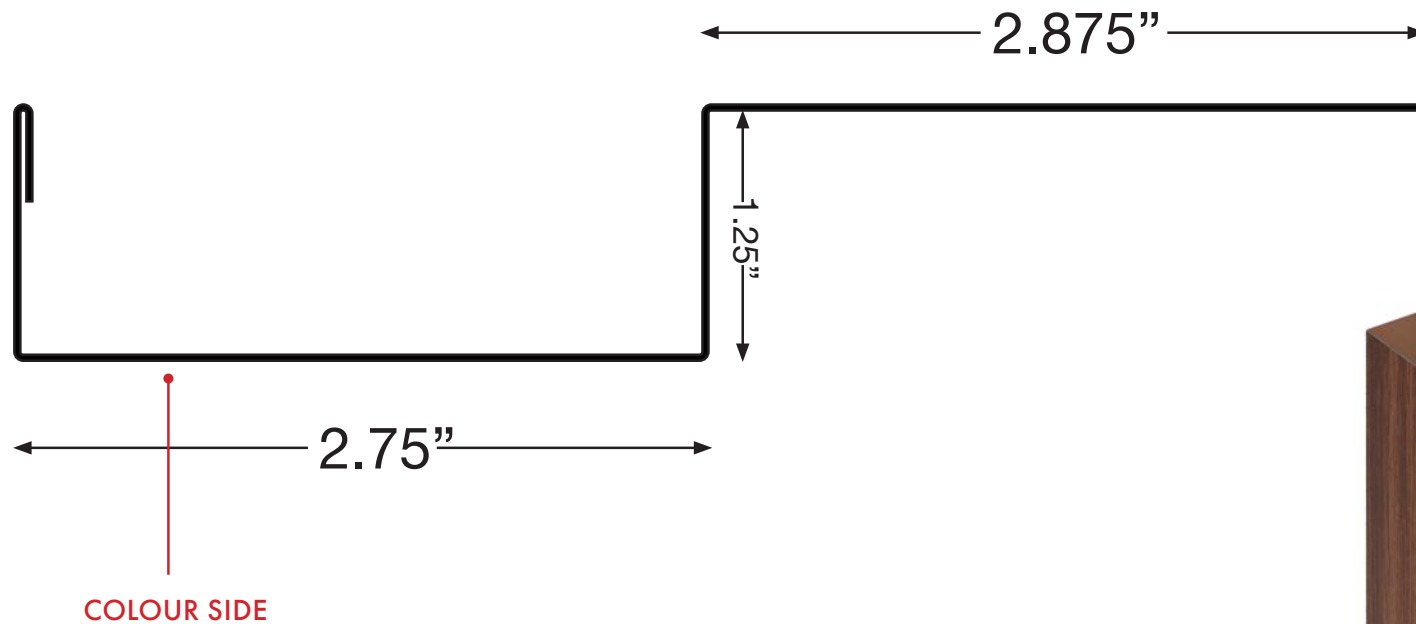

NOTES: **8.5" CUT**



1.25" U Support

BOARD+BATTEN

10': #600032

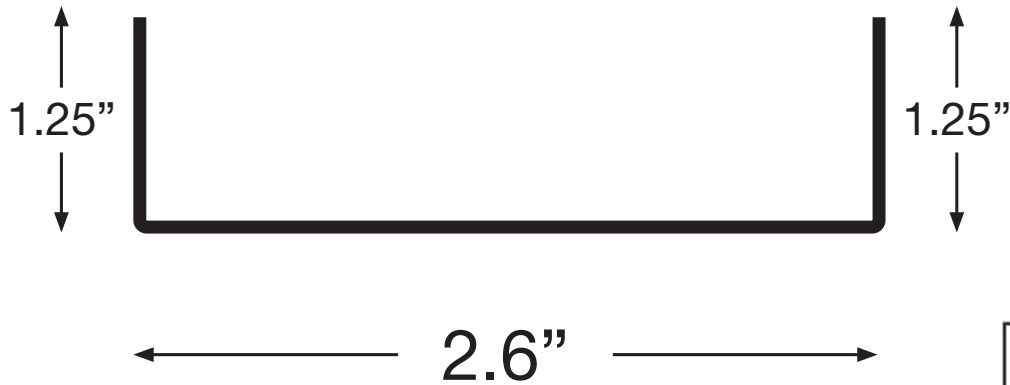

NOTES:
5.1" CUT
22 Gage
Galvanized Steel